



RVI Readout and working session

2016-04-28 09:15 – 11:30

Magnus Feuer
Head System Architect | Expert Group LEad
Jaguar Land Rover

5-Oct-15

This work is licensed under a Creative Commons Attribution-Share Alike 4.0 ([CC BY-SA 4.0](https://creativecommons.org/licenses/by-sa/4.0/))
GENIVI is a registered trademark of the GENIVI Alliance in the USA and other countries
Copyright © GENIVI Alliance 2016



Today's schedule

9:15 – 10:30	RVI Readout – Introduction, Current status, and future development
10:30 – 11:30	RVI Readout – Vehicle Signal Specification
11:30 – 12:30	Dynamic Agent Readout
14:00 – 16:00	SOTA Readout and working session

RVI Main Features





Connectivity

- Utilize a wide array of data links to setup communication to and from vehicle, either P2P or via backend serve
- Provide encryption for secrecy, non repudiation, replay attack protection, etc
- Work with OMA, IEEE, and other organizations to standardize RVI and integrate existing communication standards

Authentication

- Prove the identity of communicating parties
- Use best-of-breed open source technologies to drive peer-reviewed security

Authorization

- Prove to remote parties the right to discover and invoke their services.

Service Discovery

- Announce services available to remote parties

Service Invocation

- Invoke services and report the result over unreliable data links that may change during execution
- Support retry and store & forward of service invocations to alleviate transient connectivity

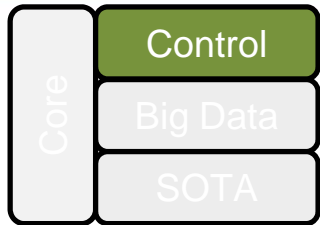

Vehicle Integration

- Utilize Networking EG components to integrate with vehicle bus
- Use W3C-based signal standards to control vehicle

Service Protocol

- Define vehicle control protocols between vehicle and remote entities

Web Services

- Use W3C-based standards to define web services for remote vehicle control

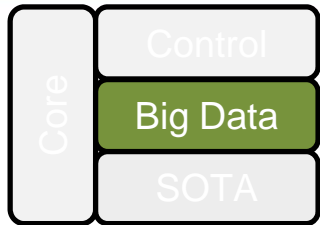

Data collection

- Integrate with GENIVI components to harvest data
- Use dynamically OTA-loadable code to securely collect and pre-process data

Reporting

- Specify and implement in-vehicle reporting services and their protocols

Data gathering

- Server-side data reception, storage, and web service access
- Work with big data industry actors to integrate analytics and data feeds into a larger ecosystem

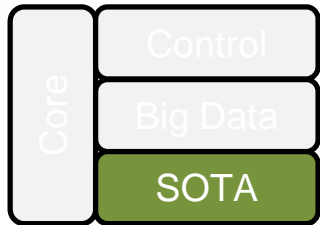

Implement and standardize SOTA Client

- Integrate SOTA Client with System Infrastructure and its Software Management activities
- Implement existing transport protocol standards in addition to Transport

Implement and standardize SOTA Server

- Specify and implement reporting services and their protocols

Integrate with industry

- Work with vendors and community to drive RVI SOTA adoption in the automotive industry

Schematics

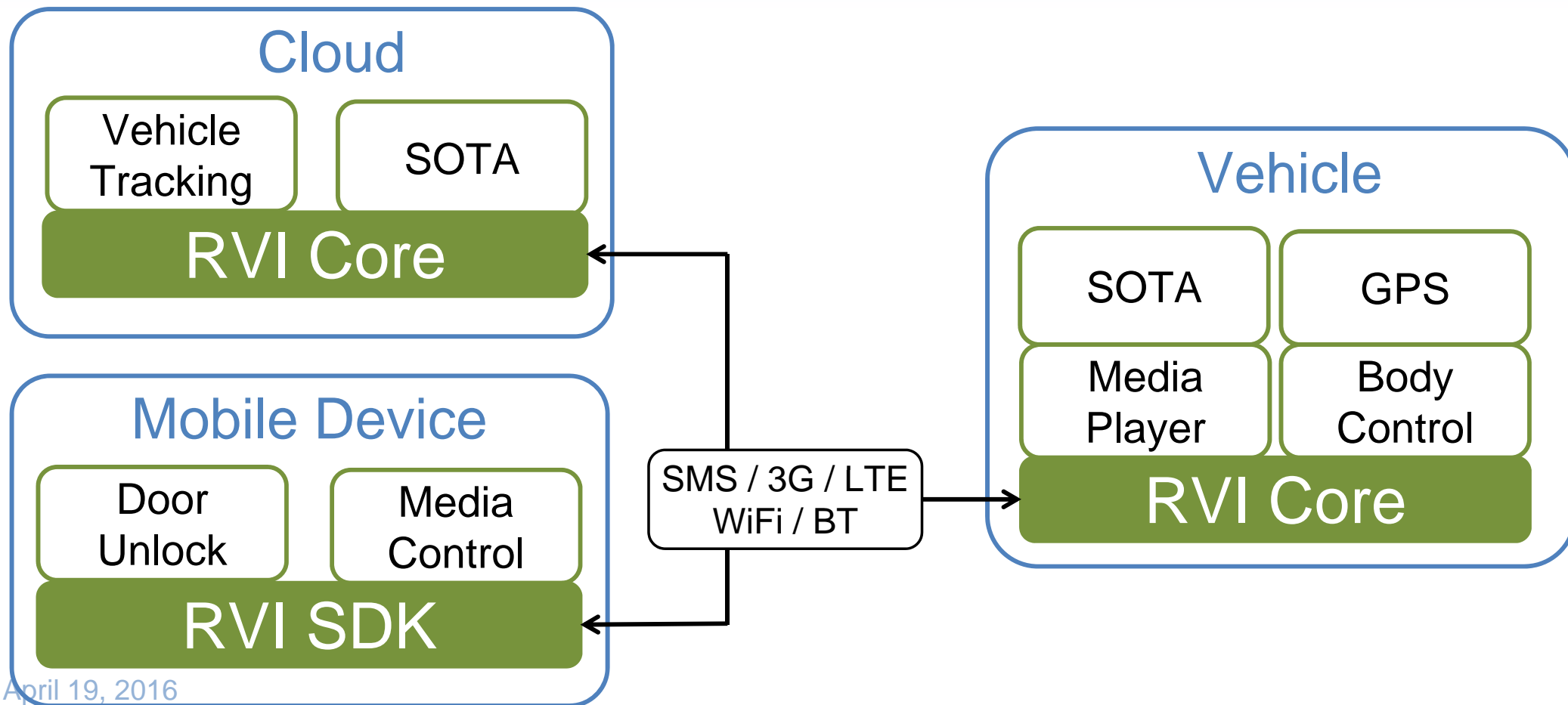

Security

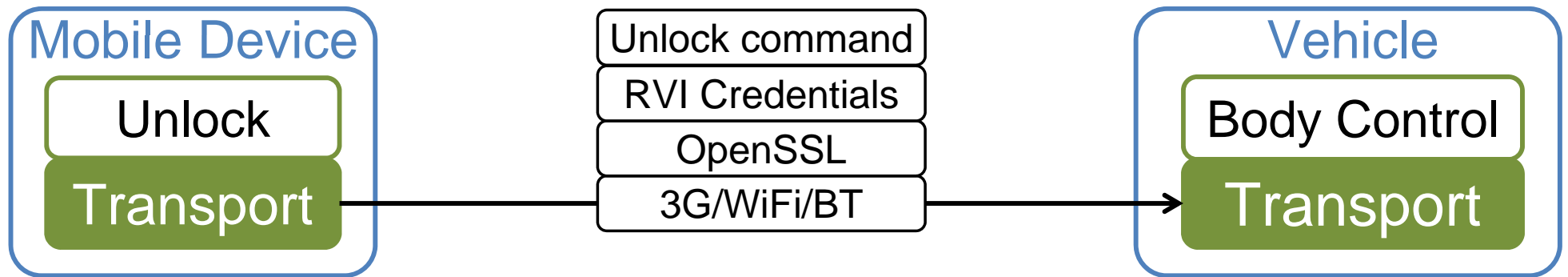

- **OpenSSL**
TLS provides core eavesdropping and MITM attack protection
- **RVI Credentials**
Signed by root server to prove device authenticity and its right to invoke unlock on the given vehicle
- **Unlock**
Will only be accepted by vehicle if validated certificate specifies device's right to invoke unlock command

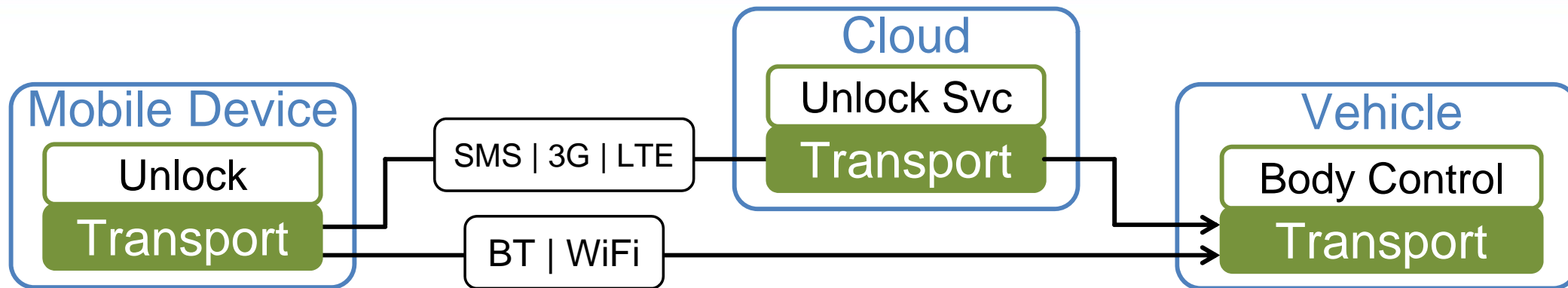

- **Multi-pathed commands**

Commands can be tried over multiple data links, both as peer-to-peer and via backend server.

- **Traffic prioritization**

Forces high-bandwidth services to use WiFi while allowing mission-critical services to use 3G and SMS.

- **Multi-protocol**

A single service (such as unlock) can employ different protocols and data links depending on the targeted vehicle type.

Status Update

April 19, 2016



Progress report: Core

- **RVI 0.5.0 released**
 - Authentication, authorization, and encryption
 - Yocto, GDP, Raspbian, Debian, and Ubuntu support

Development phase 2 accepted

- Yocto integrated
- Ready for integration with GENIVI

Advanced Telematic Systems maintainer

- Uses unmodified upstream GENIVI code in commercial offering

Example of a successful GENIVI project

- Launched by GENIVI, jointly funded, now part of product.

Separate session

Proof of concept finished

- **Demonstrated at GENIVI**

Next design phase starts now

- **Rule-based agents?**

Most interest of all RVI domains

Separate session

Progress report: Mobile SDK

IOS and Android implementation of RVI Core

- Communicates with other RVI nodes via BT and IP

Provides the necessary toolset for device-vehicle integration

- Present well-known SDK to native app developers

Can operate without Internet connection

- Self-carried credentials

Next challenge is to find killer apps

- Proposals welcome – JLR will co-sponsor

GENIVI Compliance

- Magnus Olsson will drive standardization
- Magnus Feuer will drive project



Compliance

Introducing Magnus Olsson

April 19, 2016

GENIVI is a registered trademark of the GENIVI Alliance in the USA and other countries
Copyright © GENIVI Alliance 2016

RVI 1.0 What is in the pipeline

Store and Forward

- Transactional survival of power cycles

Private Key Infrastructure

- Investigating best of breed to use

FrancaIDL

- Wrap the basic RVI commands in FrancaIDL instead of JSON-RPC

Baseline for Compliance

- Provide Magnus Olsson with necessary material to face Gunnar

C implementation of RVI Protocol

- Opens up for lightweight, embedded RVI integration

Working mode and Road Map

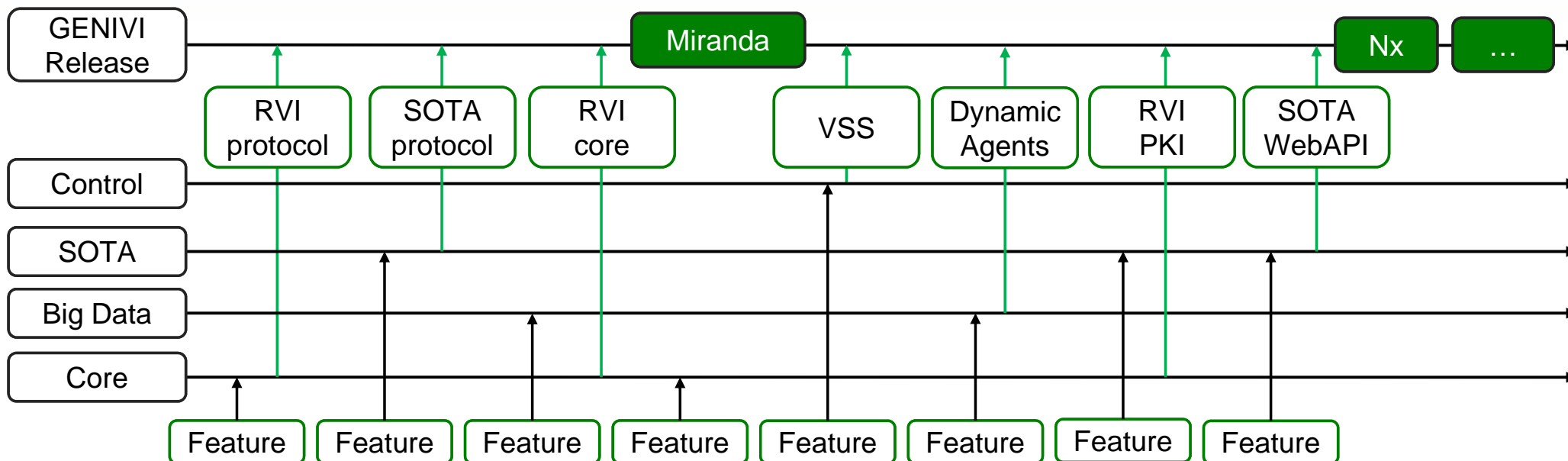

- **Project features fed into Github**
- **Projects have their own release schedule**
- **Projects feed documentation and reference code to GENIVI Release process**

Who are we working with?

"Collaborate with existing organizations (OMA, IEEE, etc) to ensure broad adoption and acceptance, and to avoid duplication and competition."



Collaboration: W3C

Rudi Streif joined as W3C Automotive Working Group co-chair

Next version of Vehicle Data Specification to be based on VSS

GENIVI SOTA WebAPI candidate for standardization

Exploring joint standardization of RVI Control WebAPI, potentially together with SmartCar

Enables end-to-end integration between the automotive and web world

Collaboration: Open Connectivity Foundation

- Joint Samsung-OCF / RVI demo at AMM
- OCF – RVI bridge demonstrating interoperability between IOT and automotive
- Exploring using Vehicle Signal Specification as baseline for OCF standard

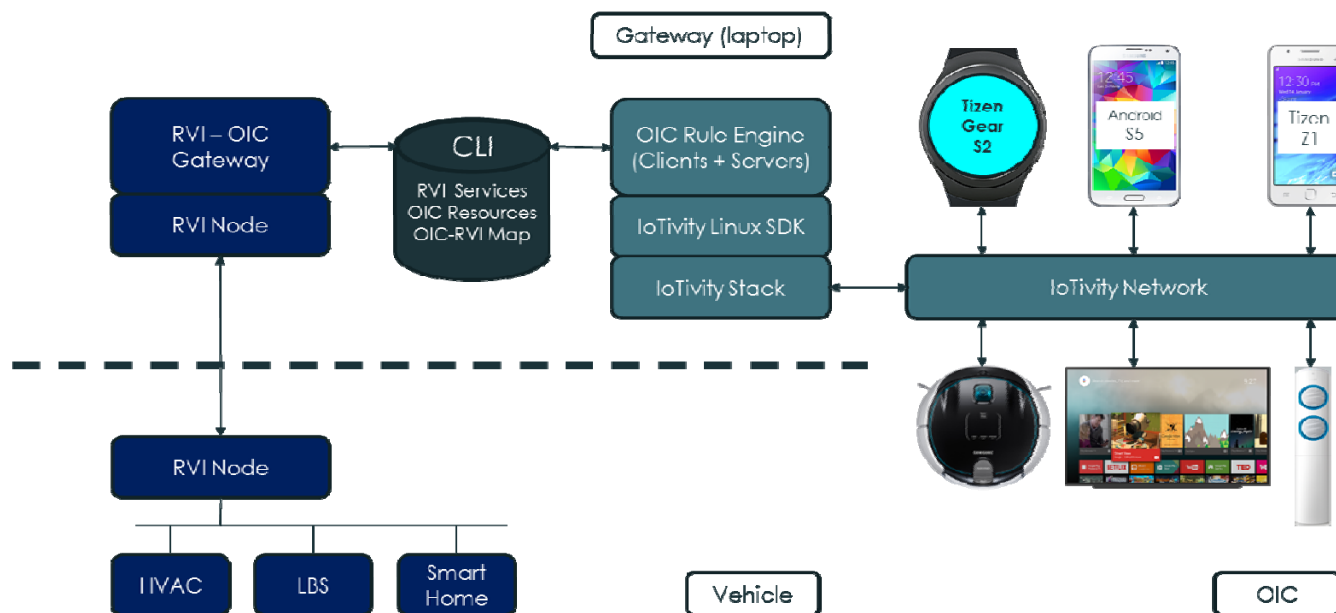



Collaboration: Open Mobile Alliance

Value adds on top of RVI Core with device management, etc.

Can provide a bridge to device management systems

Looking at elevating RVI protocol to OMA standard

EG-RVI is looking at integrating LightweightM2M



Conclusion

RVI is approaching production grade

RVI is being deployed in production projects

GENIVI has the opportunity to be the central repository for automotive web standards



Thank you!

mfeuer1@jaguarlandrover.com

+1-949-294 7871

April 19, 2016