

VSS Working Sessions

COVESA AMM

2023-10-12

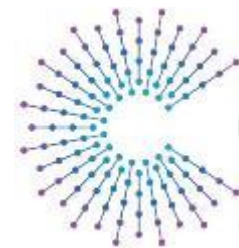

COVESA

Accelerating the future of connected vehicles

VSS Working Session

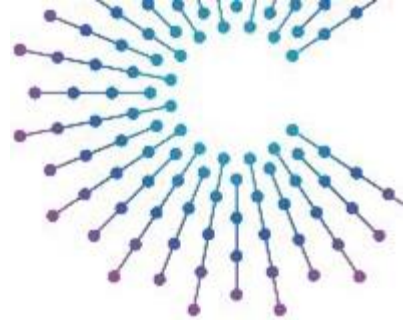

- Part 1
 - Walk through and discussion of recently presented VSS improvement areas
 - Based on presentations from Ford and Blackberry
- Part 2
 - VSS catalog evolvement
 - What to add, what to remove, ...
 - VSS format and tooling
 - What changes do we see as wanted/needed?
 - What shall we NOT change

This is supposed to be an interactive session – please interrupt!

Typical workflow of a successful change to VSS

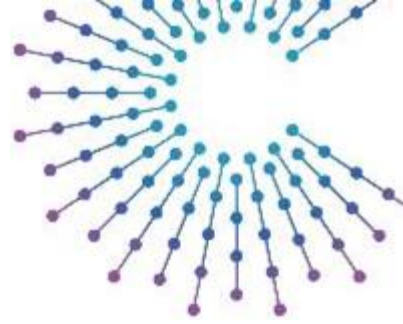

- Someone presents an idea
 - Creates an issue in VSS Github explaining the idea or problem area
 - Presents it at a VSS meeting
- We agree that the idea is good (or at least acceptable)
 - First discussed in Github and VSS Meetings
 - If needed also discussed/decided in DEG, TST, Board
- Someone volunteer to drive development
 - Creates more detailed proposals, possibly including prototypes
 - Propose time plan and acceptance criteria
 - Implements and creates Pull Requests
- Pull Requests reviewed and discussed by VSS meetings
 - When approved merged by VSS Maintainers (individuals with merge rights, typically Erik/Adnan/Sebastian)
 - Change included in next minor and/or major-release

VSS Type Representation

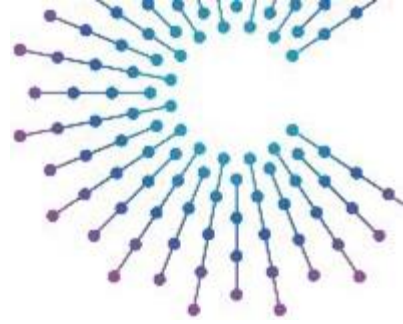

- VSS Today
 - Type of a signal is implicitly given by a combination of datatype/unit/min/max/allowed
 - “Type” reuse only possible for structs
- Idea presented
 - Define reusable properties

AmbientAirTemperature:
id: AmbientAirTemperature
name: Ambient Air Temperature
schemaElementType: **DataProperty**
definition: The temperature of the air in a site or spatial region
dataType: DataTypeSpecification.float
unit: Celsius

Temperature:
datatype: int8
type: actuator
unit: celsius
description: Temperature
definition: The degree or intensity of heat set for a HVAC station
schemaElementType: **Signal**
signalName: Vehicle.Cabin.HVAC.Station.Temperature
propertyId: AmbientAirTemperature
objectId: Vehicle.Cabin.HVAC.Station

VSS Type Representation

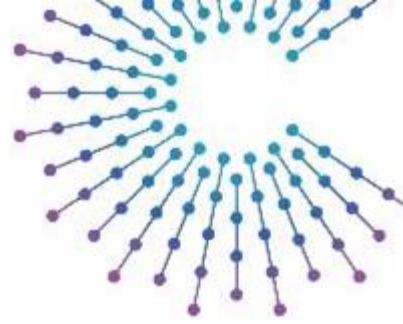

- Pros/Cons
 - Makes VSS model somewhat more complex
 - Fits quite well into the type concept we already have for structs
 - Could help keeping VSS standard catalog consistent
 - Avoid that similar signals have different type/unit
 - *"All temperature signals shall use TemperatureCelsius property!"*
- Possible VSS Solutions
 - Extend existing type/struct syntax for this purpose
 - Convert existing signals to use properties
 - Tools must be modified – Are two flavors needed, one that keep property information and one that expand/replace property information to keep backward compatibility?
- Discussion – What is your opinion?

Notes

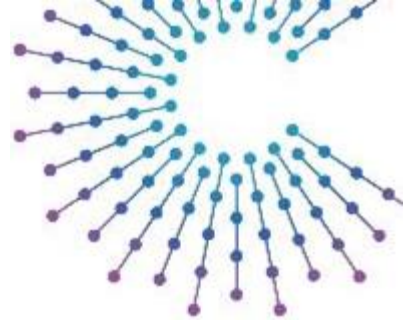

- In general unit/domain seems to be a topics to investigate further
- Some participants proposed that signals ONLY shall specify dimension/domain/quantity (for example "Distance"/"Length") rather than specifying a particular unit (like "meters")
 - Observations should then consist of value+unit pairs
- But "unitless" downstream projects like VISS and KUKSA need to have a "default unit", as they only pass a value.
- Initiative to rework unit file in https://github.com/COVESA/vehicle_signal_specification/pull/669

Tree vs Flat Structure

- VSS Today
 - One Root
 - Branches more or less used as namespaces
 - No real distinction between classes and objects
- Ford Idea (our interpretation)
 - No real requirement to have a tree
 - We may have “hierarchical dot notated names” but not necessarily
 - It is up to the child to declare it’s father rather than opposite
- Related comments
 - We have previously got comments that VSS expanded name are too long for some environments where identifiers have a max length.

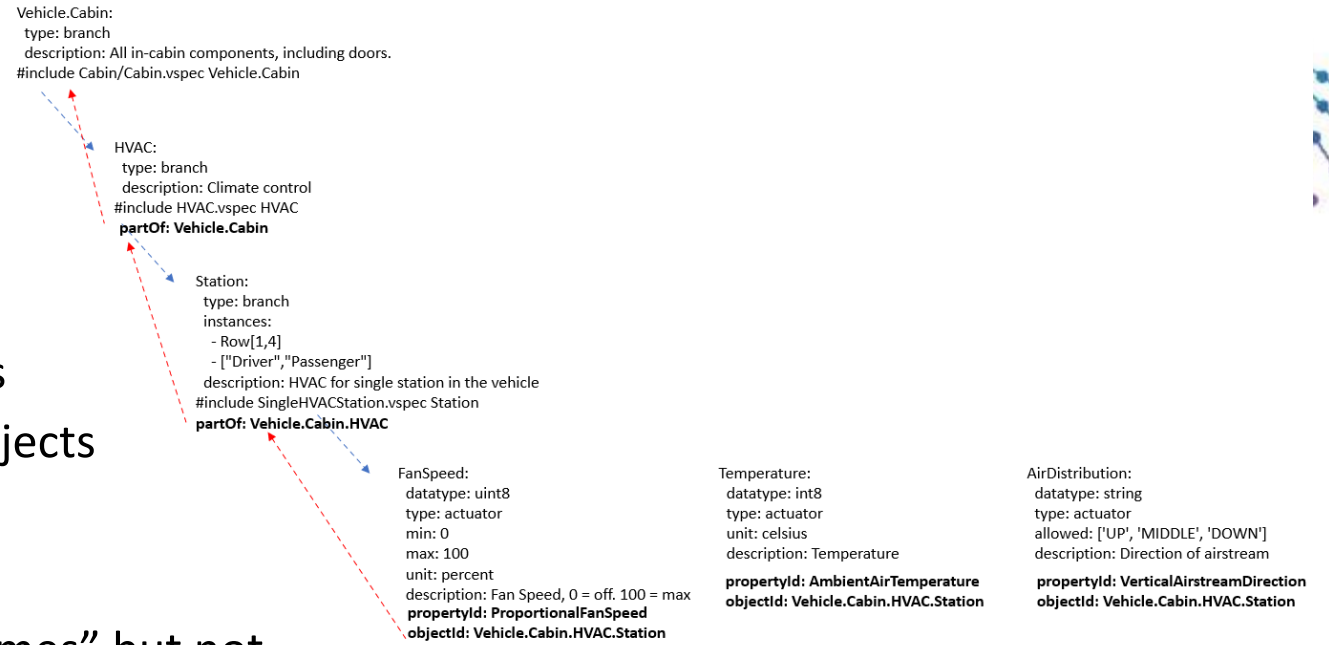

Tree vs Flat Structure continued

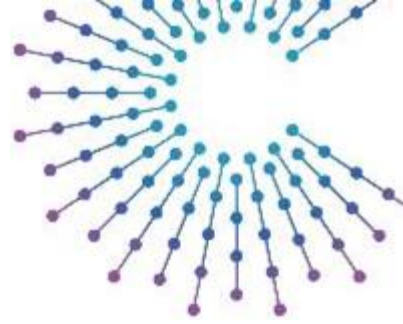

- Implications and Discussion Topics
 - This would be a big change if performed in *.vspec files
 - And if so, a good point in time to discuss if *.vspec shall be kept as source format
 - Generating “old style” expanded Yaml/JSON from new format doable, if needed
 - Even if we “scrap” branches – do we still need some namespace mechanism and support for relative addressing?
- Discussion – What is your opinion?

Notes

- No real traction for changes here

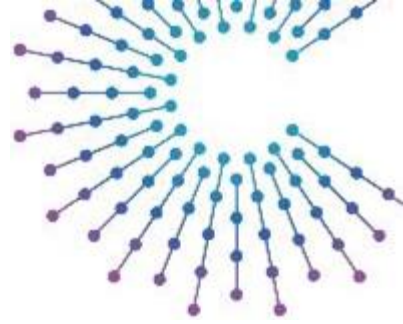

Instances

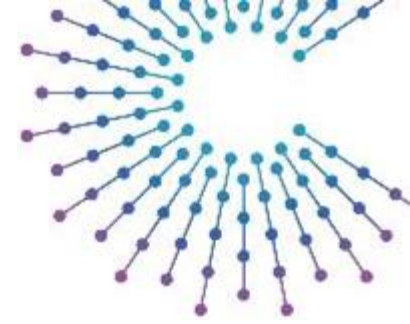

- VSS Today
 - Instances defined on branch
 - Syntax limited, basically enum and/or array
- Ford Idea (our interpretation)
 - You define objects instead of specifying instances in the class
 - Arbitrary Identifier, not necessarily following VSS “expanded names”
 - Possibility to define static object data
 - Like “LateralPosition” in image
- Related comments
 - Some downstream projects like Eclipse Velocitas prefer to work with unexpanded paths to allow methods like “getHVAC(row,pos)”

MDP – Invert Tree Syntax - Instances

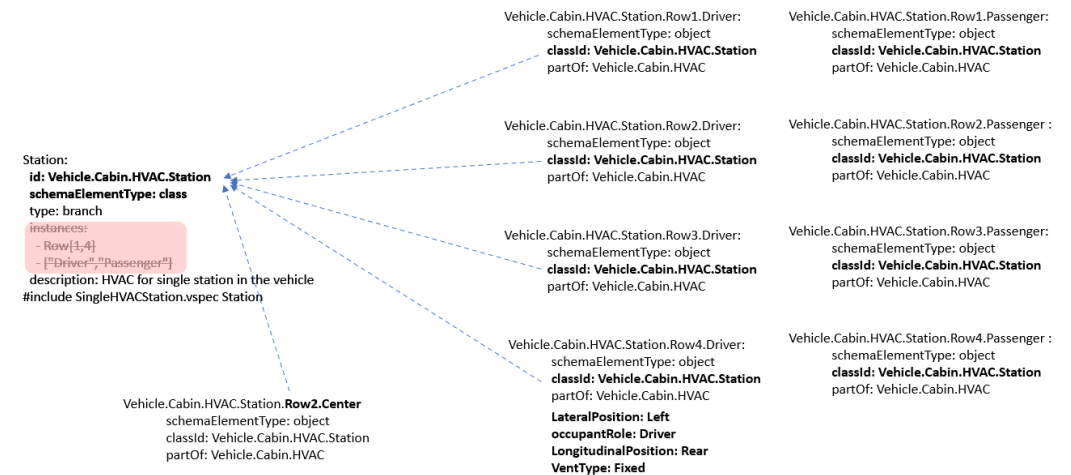

Instances continued

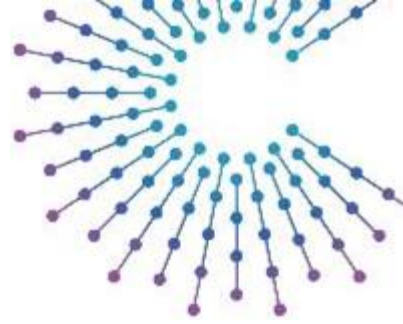

- Implications and Discussion Topics
 - Instances is common discussion point for VSS
 - The current style forces us to have “default size” for number of doors/seats/HVACs as you MUST specify instances at standard catalog level
 - Current VSS solution has some possibility to add signals for a specific instance by overlays specified by expanded name. Would require a different solution if using this syntax (class inheritance to allow addition of signals?)
 - Do we need a special mechanism to specify that “LateralPosition” is a “const signal/attribute” of HVACStation, i.e. something that must be given when instantiating, i.e. something that an SDK can use to find a matching HVAC station?
- Discussion – What is your opinion?

Notes

- Audience seems to be positive to change instance representation
- Partially related to https://github.com/COVESA/vehicle_signal_specification/issues/642 , that issue can be used for discussion

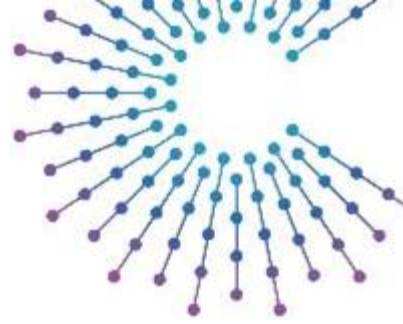

Signal type

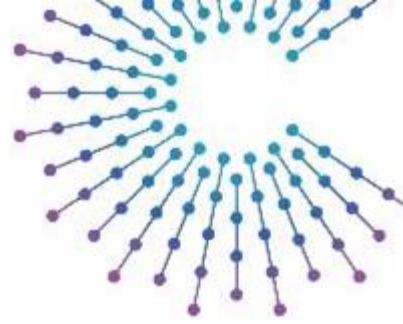

- VSS today
 - Signals are specified as attribute, sensor or actuator
 - These types are often confusing, as there may not be a real sensor behind, the value may be calculated
 - What a client can do may anyway be limited by access rights
 - But distinction may serve a purpose in deployments
 - An actuator has both a current value and a wanted value, sensor/attribute has only current value

IsRecirculationActive:

~~datatype: boolean~~

~~type: actuator~~

~~description: Is recirculation active.~~

id: Vehicle.Cabin.HVAC.IsRecirculationActive

name: Vehicle.Cabin.HVAC.IsRecirculationActive

schemaElementType: Signal

propertyId: IsActive

objectId: Vehicle.Cabin.HVAC.Recirculation

definition: Indicates whether the cabin air is be

isDefinedBy: FordMotorCompany, COVESA

definitionSource: VehicleSignalSpecification



Signal type - continued

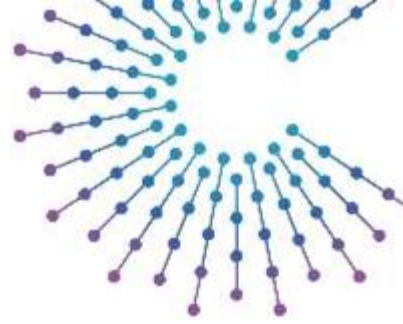

- Implications and Discussion Topics
 - Some distinction may be useful
 - Example: Vehicle.Speed is never intended to be actuatable (we think). Hood.IsOpen may be it in some vehicles
 - I.e. no value in that an API generate a “setTargetSpeed(float value)”
 - Ontology guys sometimes differentiate between Observable Properties and Actuatable Properties
 - Does anyone make a distinction between attribute and sensor in their implementation?
- Discussion – What is your opinion?

Notes

- Agreement on that terms are confusing, but no agreement whether better terms exist or not
- Some advocate this is just deployment information
- Partially related to https://github.com/COVESA/vehicle_signal_specification/issues/633

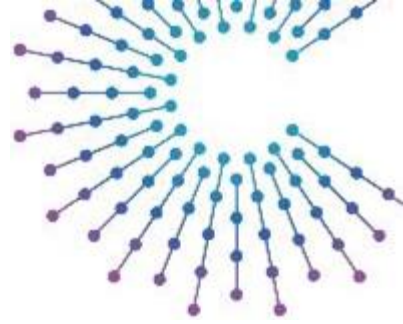

Description/Definition

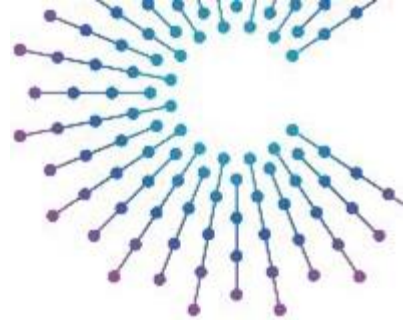

- Ford proposal
 - Replace “description” with “definition”
- VSS Today
 - No real definition exists on what should be part of “description”
- Implications and Discussion Topics
 - Is the purpose of the current “description” and the intended “definition that different?
 - I.e. is just “definition” a better name, or do we need both?
- Discussion – What is your opinion?

```
IsRecirculationActive:  
datatype: boolean  
type: actuator  
description: Is recirculation active.  
id: Vehicle.Cabin.HVAC.IsRecirculationActive  
name: Vehicle.Cabin.HVAC.IsRecirculationActive  
schemaElementType: Signal  
propertyId: IsActive  
objectId: Vehicle.Cabin.HVAC.Recirculation  
definition: Indicates whether the cabin air is being recycled  
isDefinedBy: FordMotorCompany, COVESA  
definitionSource: VehicleSignalSpecification
```



Notes

- Audience seems to think definition is better
- Erik to check meaning with Alan
- PR proposal for introducing definition at https://github.com/COVESA/vehicle_signal_specification/pull/671

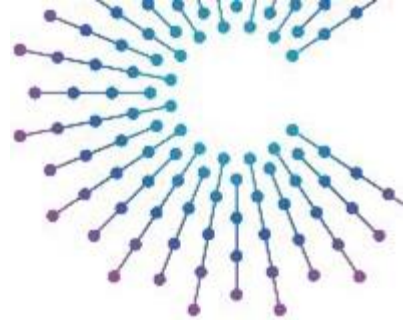

Permission Model

- VSS Today
 - Does not specify anything, not even a syntax
- Implications and Discussion Topics
 - Access rights can likely never be specified in VSS standard catalog
 - But we could specify “recommended methods” where we define syntax allowing VSS models to be annotated
 - We could extend tooling to check for consistency
- Discussion – What is your opinion?

Permissions File	Signal Catalog File
<pre> "x-read-permission": [{ "permission": "Vehicle.READ", "nodes": ["Vehicle"] }, { "permission": "Vehicle.PII.READ", "nodes": ["Vehicle.VehicleIdentification", "Vehicle.Driver.Identifier"] }] </pre>	<pre> "Speed": { "datatype": "float", "description": "Vehicle speed.", "type": "sensor", "unit": "km/h", "uuid": "efe50798638d55fab18ab7d43cc490e9", "x-euuid": "86e92e0ee67d30dd", "x-read-permission": "Vehicle.READ" }, </pre>

Notes

- No conclusion

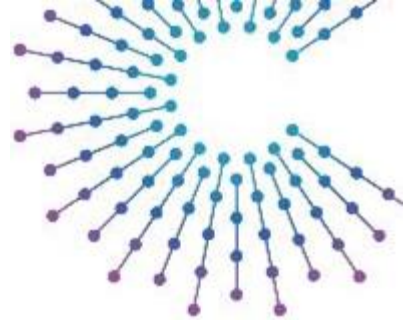

UUID

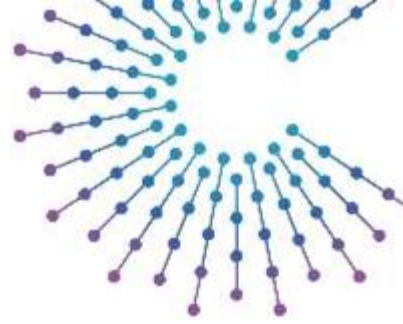

- VSS Today
 - We have UUID based on path name, but method not well described
 - No method to use other UUID, a different UUID method or to reuse old UUIDs and map UUIDs
- Implications and Discussion Topics
 - What use cases do we intend to solve
 - Short identifiers to reduce message length?
 - Mapping signals with same content
 - Identify changes compared to standard VSS or compared to previous version
 - Do we think one method would suffice?
 - Or do we think it will be use-case dependent?
- Discussion – What is your opinion?

PERMISSION SUPPORT AND EUUID GENERATION

Permissions File	Signal Catalog File
<pre>"x-read-permission": [{ "permission": "Vehicle.READ", "nodes": ["Vehicle"] }, { "permission": "Vehicle.PII.READ", "nodes": ["Vehicle.VehicleIdentification", "Vehicle.Driver.Identifier"] }]</pre>	<pre>"Speed": { "datatype": "float", "description": "Vehicle speed.", "type": "sensor", "unit": "km/h", "uuid": "efe50798638d55fab18ab7d43cc490e9", "x-euuid": "86e92e0ee67d30dd", "x-read-permission": "Vehicle.READ" },</pre>

Notes

- To be discussed when BMW contribute their UUID model

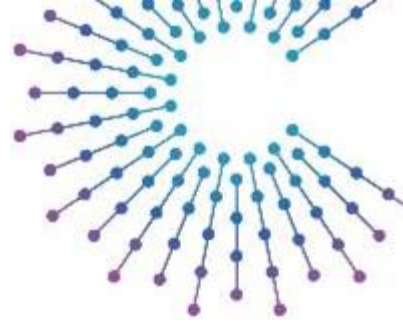

VSS Catalog evolution – VSS History

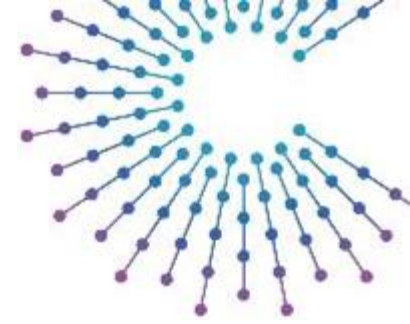

- Focus on signals needed by “vehicle users”
 - infotainment, apps
 - Remote unlock, check fuel level, ...
- QM only, i.e. not intended for safety critical features
 - Primarily not intended for “zones”, at least not with a generic key-value-based solution like KUKSA or VISS
- Shall be vehicle focused, but may be intended for both off-board/on-board usage.
 - Example: Vehicle color may be totally irrelevant to store on-board, but is relevant in a vehicle database
- Aggregated data on fleet level is not within the scope of VSS
 - Example: Average distance between accidents
- Even if VSS use the terms “actuator” and “sensor”, they do not necessarily map to a physical sensor/actuator
 - Actuator: Something where a user can set a target value
 - Example: Vehicle.HVAC.Temperature
 - Sensor: Something that typically varies over time, but a user cannot set target value directly
 - Example: Vehicle.Speed

Overview of Logical Architecture

Focus on functional integration and data architecture

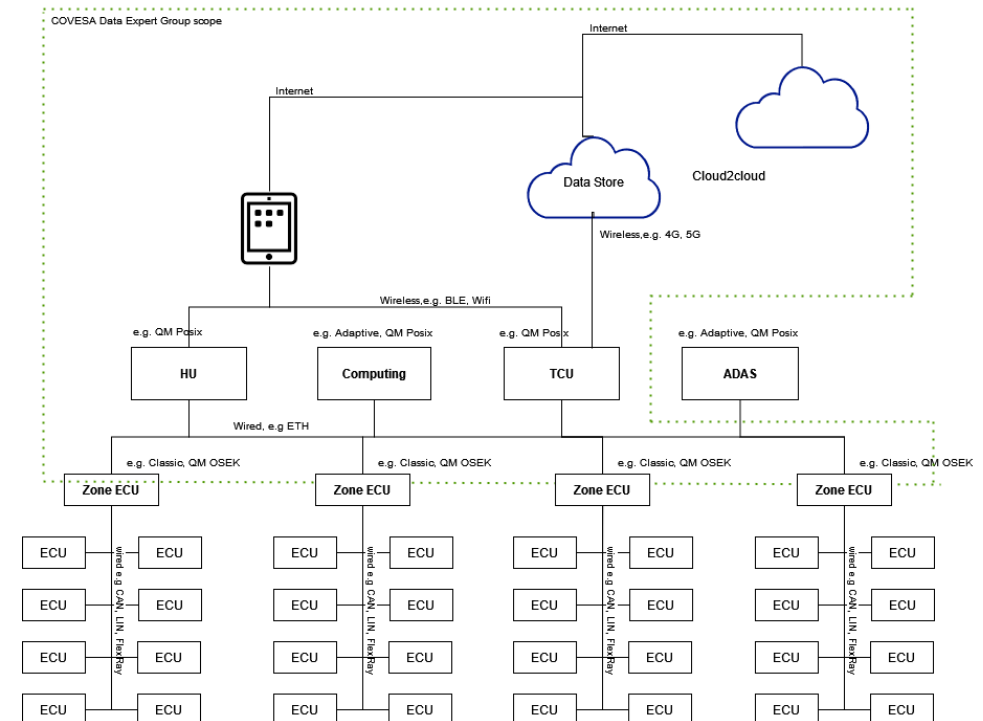

VSS Catalog – Trends and Change Methodology

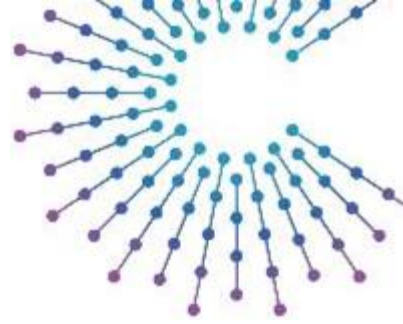

- Most low hanging fruit already picked, signals are becoming more complex
 - Just studying an individual signal is not enough, you need to study some concept documentation
 - Examples: PowerOptimize, WiperSystem
- Smaller non-controversial changes
 - Just make a Pull Request
- Larger changes
 - Create Issue/PR for discussion
 - If needed, create a COVESA task group or project with members interested in this topic:

VSS Catalog – Recent discussions - OBD

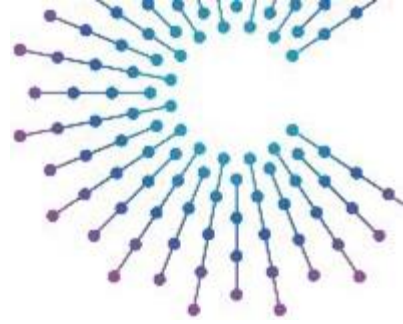

- VSS has an OBD branch which often triggers discussion
- Arguments Against
 - VSS and VSS-implementations (like VISS, KUKSA) are likely not feasible to provide data on the OBD-II interface due to latency/frequency requirements
 - Many signals in the branch are duplicates of similar signals in other parts of the tree
 - VSS shall not include 1:1 copies of other standards
- Arguments For
 - OBD-tools are expensive, making data like Diagnostic Codes (DTC) available over VSS could be useful for vehicle owners, so they can view data in an App on their mobile phone
- One possible solution (which seems to be preferred/acceptable by many)
 - Remove OBD-branch
 - But first add relevant signals to other places in VSS Tree
 - DTCs are frequently mentioned
 - But are others of interest, like lambda sensor readings?
- Discussion – What is your opinion?

VSS Catalog – Other improvements Areas

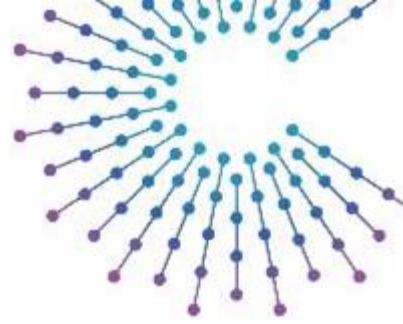

- We recently had a PR addressing the “Driver branch”
 - Fatigue, Attentiveness, Eyes on road, ...
 - That branch appears to not be that mature, and if there are multiple parties interested this could be a candidate for a task force/sub-project to identify needed changes.
- Discussion – What other areas do you see where changes would be beneficial?
 - Any areas you would be interested in driving?

Notes

- Conclusion: Make OBD deprecated, add proposals for useful data not present elsewhere (Diagnosis, Oxygen sensors, ...)
- https://github.com/COVESA/vehicle_signal_specification/issues/635

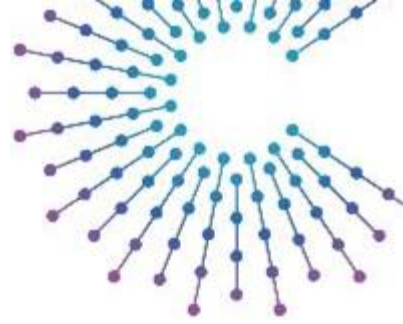

VSS Format and Tooling

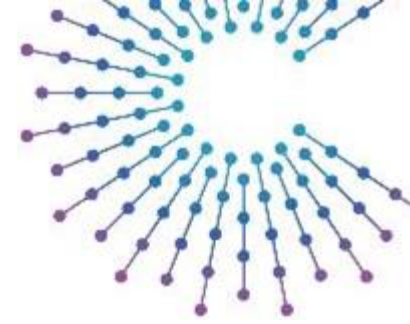

- Current Python Tool-Chain
- Includes some variation points
 - With/Without UUID
 - Expansion of instances (or not)

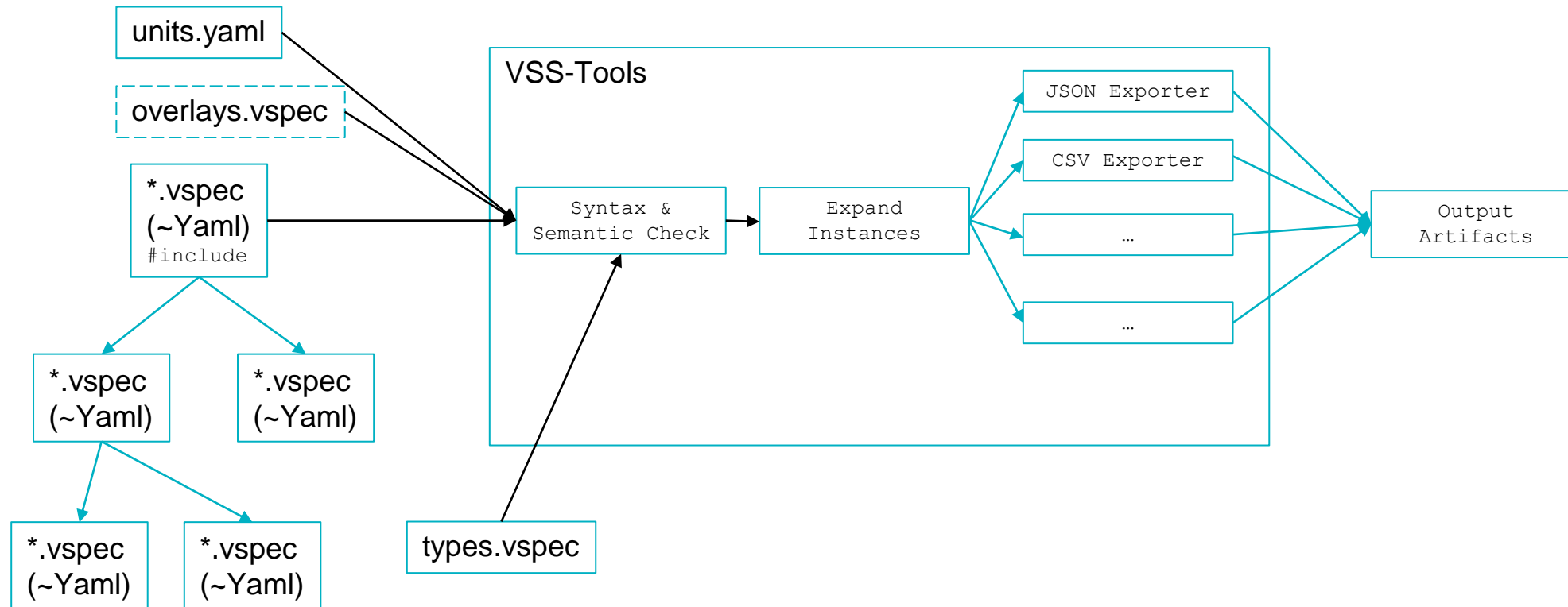

VSS Format and Tooling

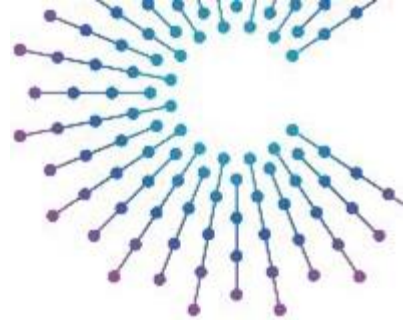

- The use of *.vspec (basically Yaml with some extensions) as source format is sometimes challenged
 - Does not fit that well with “ontology” representation, or the representation proposed by Ford
 - Limited out of the box support, like schema definition
- Some ideas presented would require major changes to VSS, i.e. if we think that we need some other source format now might be a good time to do it.
- We always strive to minimize amount of changes that are backward incompatible
 - But we do not really know what all downstream projects use as input
 - So difficult to say what the consequences would be
- Examples:
 - Eclipse KUKSA use JSON generated by vss-tools as input. As long as we can generate JSON that looks like today the actual VSS source format (today *.vspec) does not matter
- Two major approaches to support more complex models
 - Keep *.vspec as of today, annotate it if needed so that vss-tools can generate more complex model, for example generating classes/objects/properties
 - Drawback: Makes tooling more complex
 - Replace *.vspec with “something else”. Derive *.vspec and/or current export results (CSV, JSON, ...) from it.
 - Drawback: Completely new tooling required
- What is important for you concerning VSS Format and Tools?

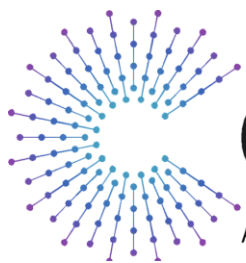

COVESA

Accelerating the future of connected vehicles

